

# T O W N H O M E

## ESSENTIAL FEATURES



## 75 BRAUN AVE

NORTHCREST TOWNS, TILLSONBURG

## THE DETAILS

PRICE	\$510,000
CLOSING DATE	AVAILABLE NOW
LOT NUMBER	103B, PHASE 2
BEDROOMS	3
BATHS	2.5
SQFT	1568
GARAGE	1
MODEL	2 STOREY TOWN

**HAYHOE™**  
— HOMES —



## SALES PROFESSIONAL

LAURA BABCOCK

519.520.0539

[laura.babcock@hayhoehomes.com](mailto:laura.babcock@hayhoehomes.com)

# SITE PLAN

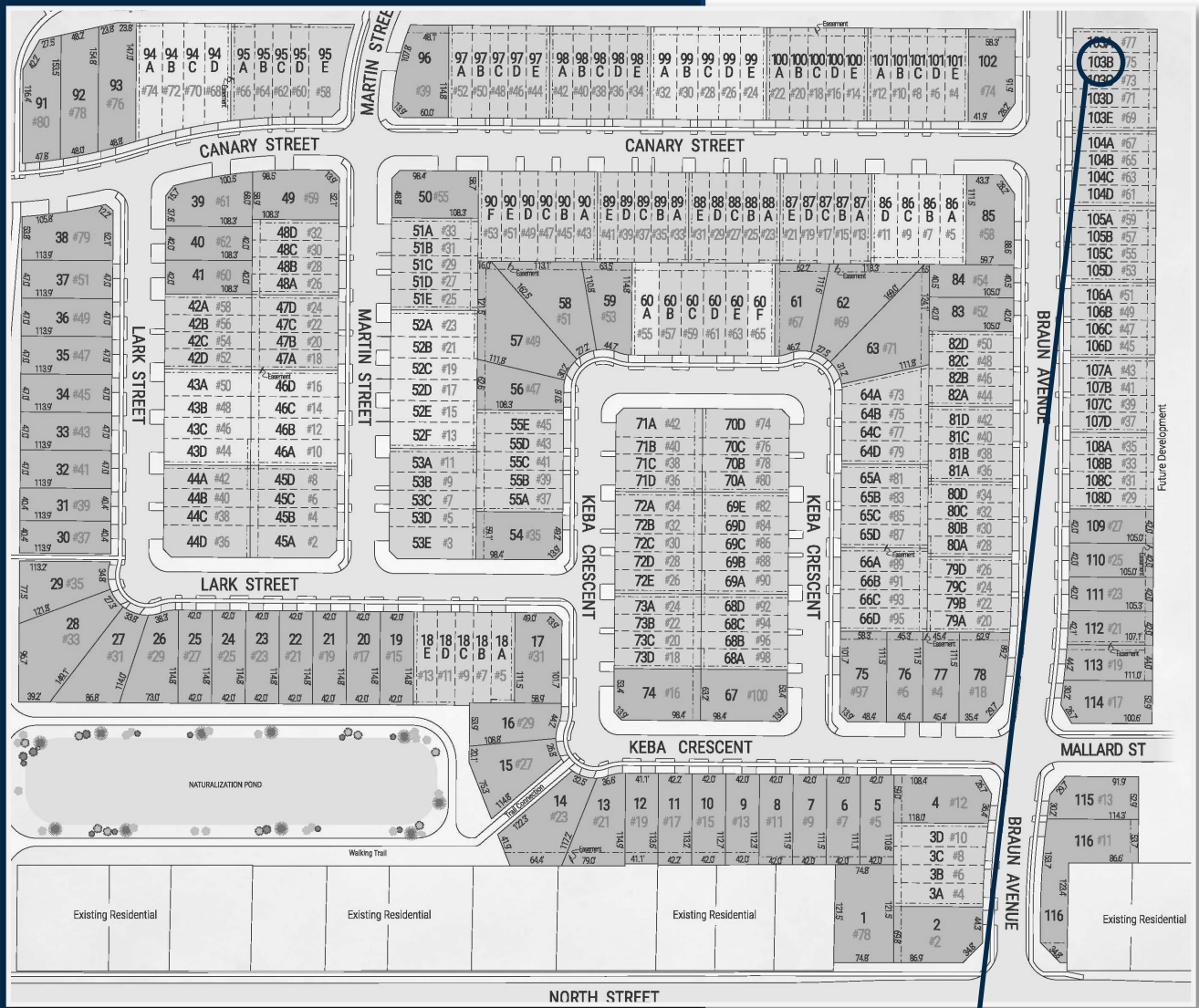

## 75 BRAUN AVE

### EXTERIOR FEATURES:

- KEYLESS ENTRY
- TREATED WOOD DECK
- ASPHALT DRIVEWAY
- WALKING TRAILS

**HAYHOE**<sup>TM</sup>  
HOMES

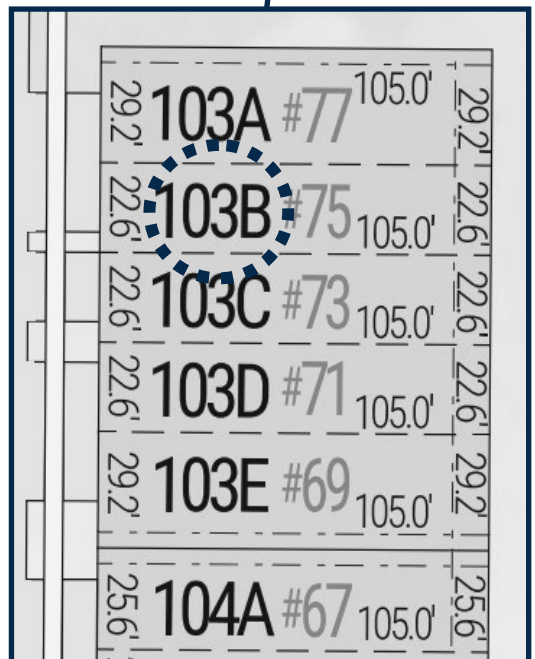

**NORTHCREST**  
**TOWNS**

# MAIN FLOOR

75 BRAUN AVE, TILLSONBURG

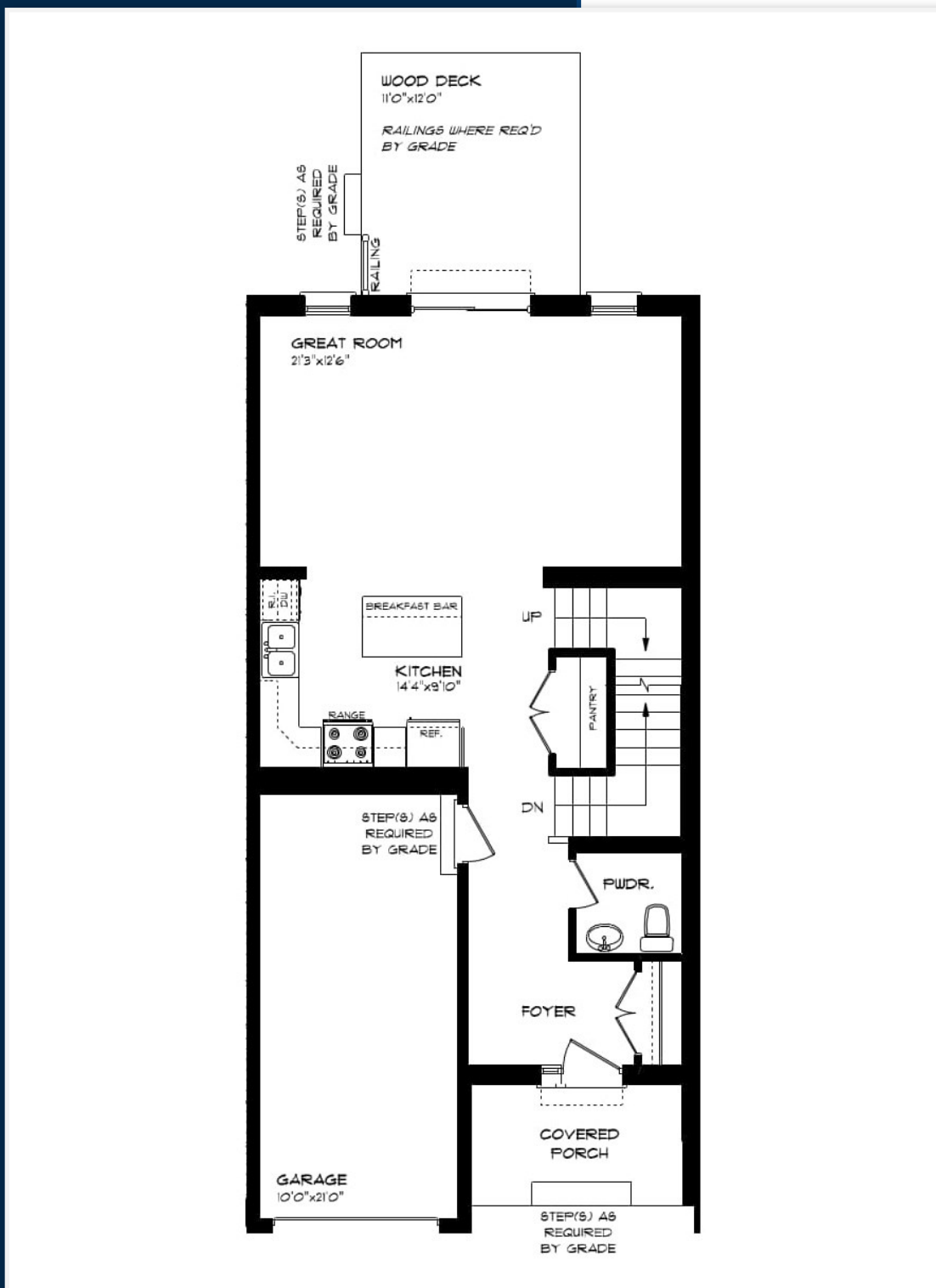

SINGLE CAR GARAGE

KITCHEN ISLAND

VINYL PLANK FLOORING

QUARTZ COUNTERTOPS

UNDERMOUNT SINK

MAIN FLOOR:  
APPROX 725 SQFT

**HAYHOE**<sup>TM</sup>  
— HOMES —

# SECOND FLOOR

75 BRAUN AVE, TILLSONBURG

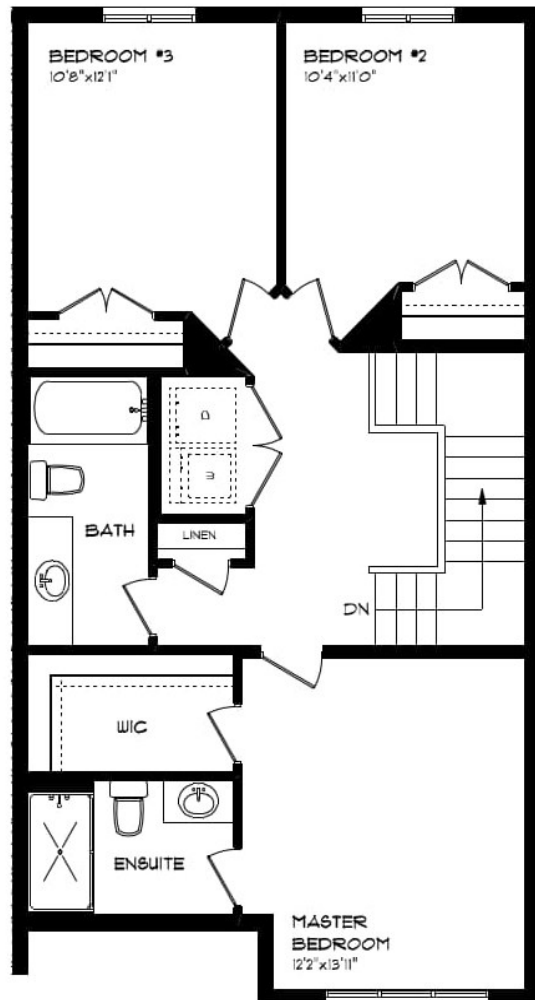

SECOND FLOOR:  
APPROX 843 SQFT

SECOND FLOOR LAUNDRY  
PROFESSIONALLY DESIGNED  
CARPET FLOORING  
VINYL PLANK FLOORING  
WALK-IN CLOSET

**HAYHOE™**  
— HOMES —

# BASEMENT

75 BRAUN AVE, TILLSONBURG

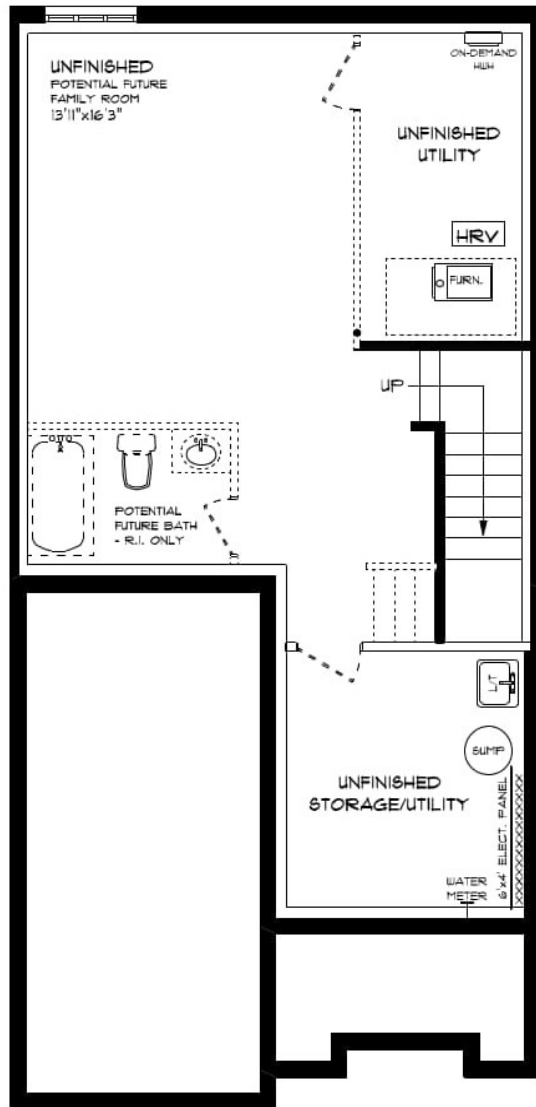

BASEMENT:  
UNFINISHED

AIR CONDITIONING  
GAS FURNACE WITH HRV  
HUMIDIFIER  
NEW HOME WARRANTY

**HAYHOE™**  
— HOMES —

# INTERIOR FINISHES

## 75 BRAUN AVE



LUXURY VINYL PLANK

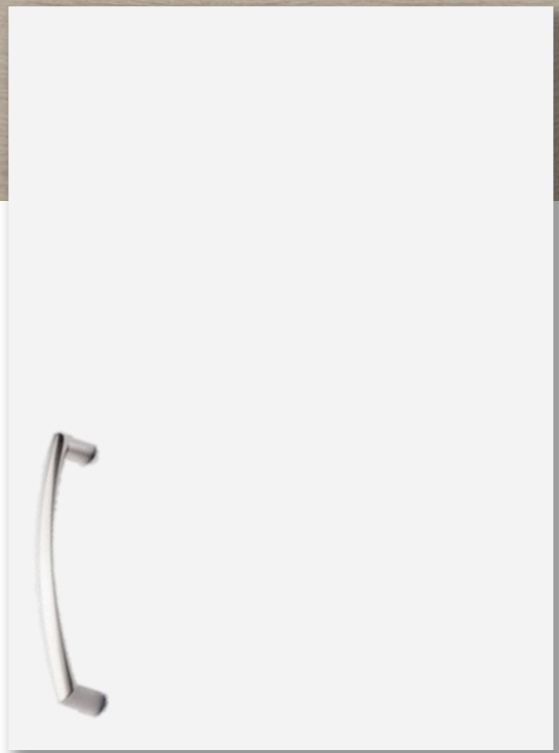

ISLAND  
PENDANTS



KITCHEN  
CABINETS

# INTERIOR FINISHES

## 75 BRAUN AVE

INTERIOR DOOR STYLE



CARPET



BATHROOM  
COUNTERTOP

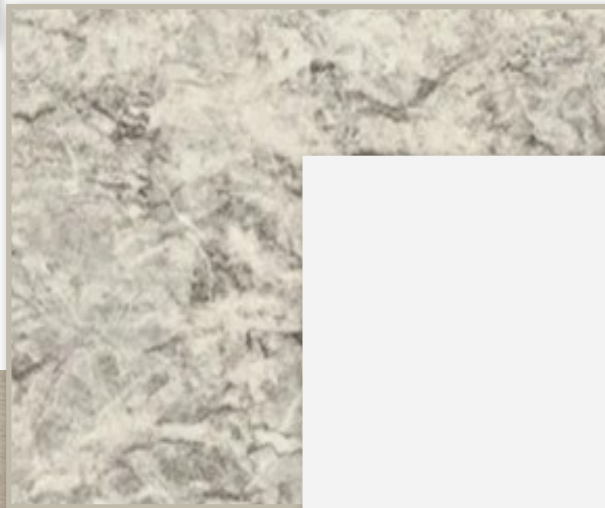

BATHROOM  
CABINERY

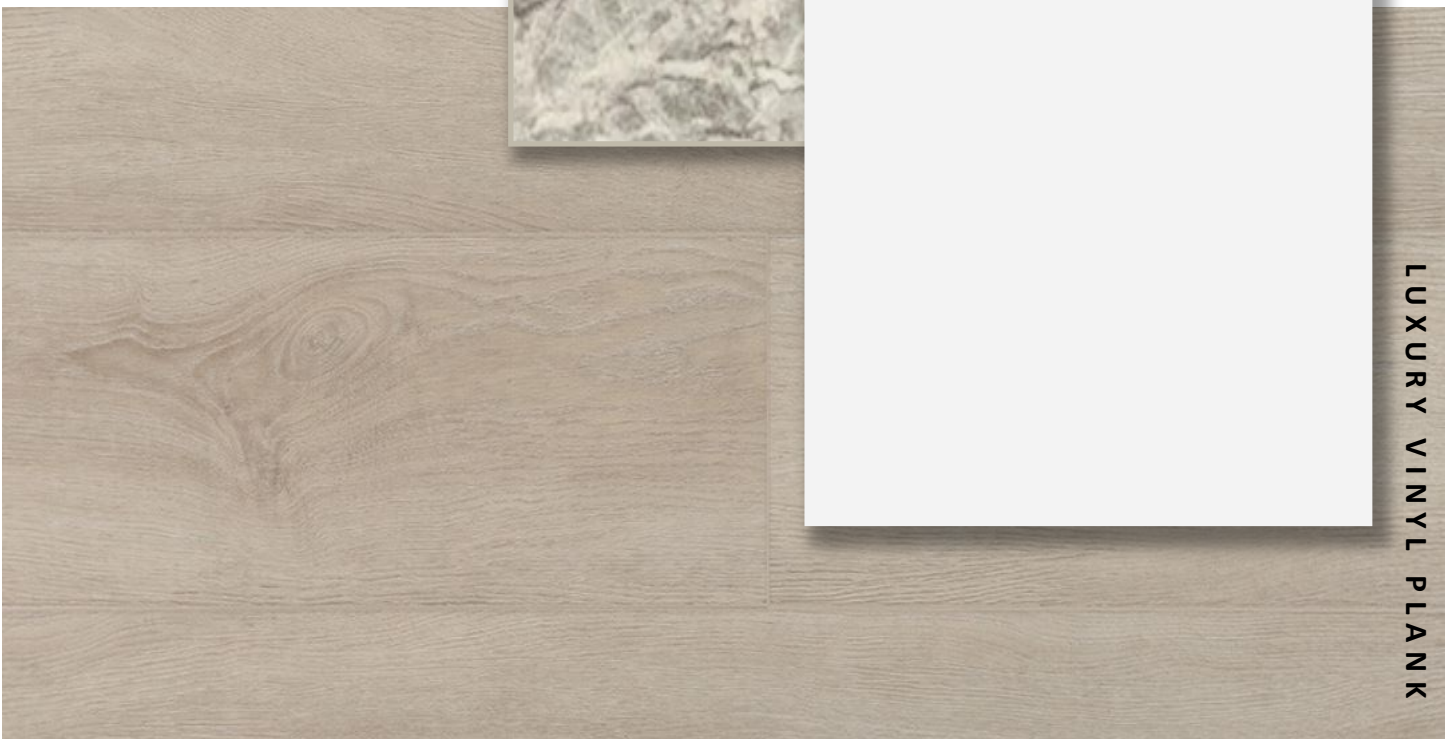

LUXURY VINYL PLANK

